

1

2

3

4

5



6

7

8

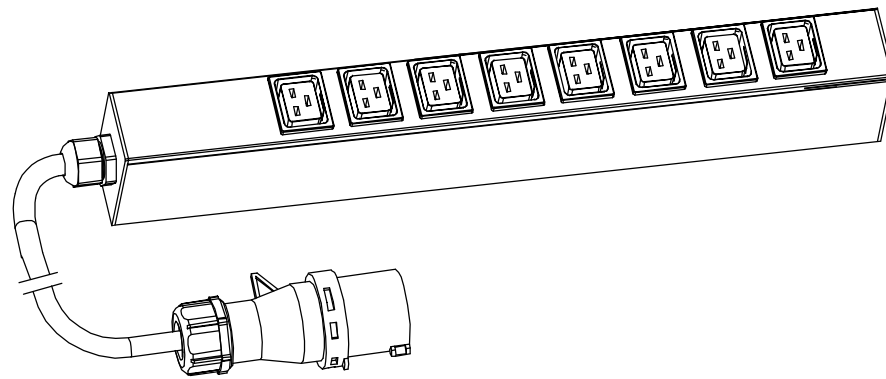
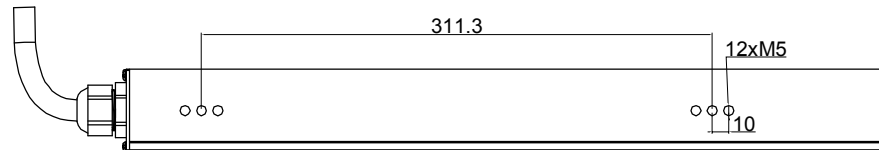
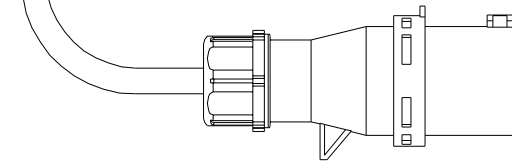
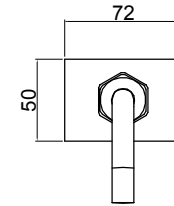
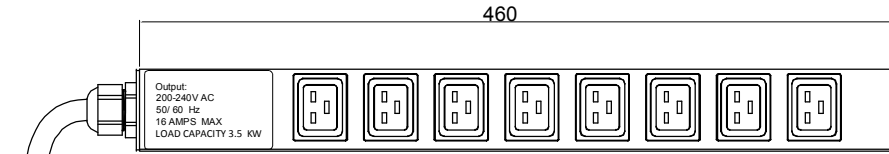
RoHS Compliant



DRAWING TYPE		IEC450816AV	
 <small>(NO PERMISSION, NO CHANGING)</small>		Housing Aluminium Black Powder coating	
unit=mm			
TECHNICAL STANDARD 1.IT11; 2.NO RUSTNESS 3.NO FLAW ON THE SURFACE		SCALE 1:3 DATE 04-07-2017	
FILLET R0.5 ANGLE ±0.5°			
FIRST ANGLE 			

Basic Series	OUTPUT (8) IEC 60320 C19 (16A Rated)	OPERATING TEMPERATURE 0° to 60°C
INPUT 250VAC 16A 50HZ IEC60309 16A 1Phase plug 3M H05VV-F3G1.5mm Power lead	BRANCH CIRCUITS (NONE)	MOUNTING ACCESORIES (2) IPFIX001 (2) IPFIX002 (2) IPFIX003

Revisions		
Rev	Description	Date

1

2

3

6

7

8